

Projektin nimi:		Okt Matti Mallila / ontelolaatat: Mallitie 1, 12345 Mallila				
Taso nro:		talo		Päiväys:		20.9.2007
Selite:		Alapohja		Rev:		
Suunnittelija:		Into Insinööri				
Elementtitunnus		Kpl	Pituus [mm]	Leveys [mm]	Paino [Tn]	Huom. / muutos
Tuotetyyppi	Tunnus					
P20	1	1	4890	900	1.08	kavennettu
P20	2	8	4890	1200	1.44	
P20	3	2	3490	1200	1.03	
P20	4	1	3490	1200	1.03	
P20	5	1	3490	1200	1.03	
P20	6	1	6370	300	0.47	kavennettu
P20	7	1	6755	1200	1.99	
P20	8	1	7152	1200	2.10	
P20	9	1	7152	1200	2.10	
P20	10	1	6829	1200	2.01	
P20	11	1	6370	1200	1.87	
P20	12	5	4870	1200	1.43	
P20	13	1	6370	1200	1.87	
P20	14	3	6370	1200	1.87	
yht.		28				

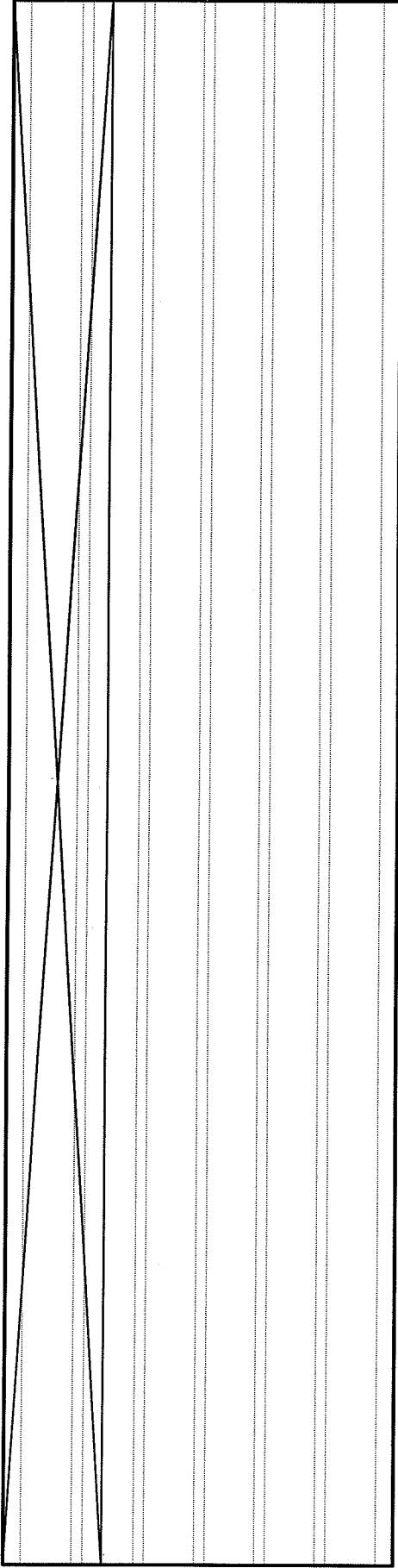

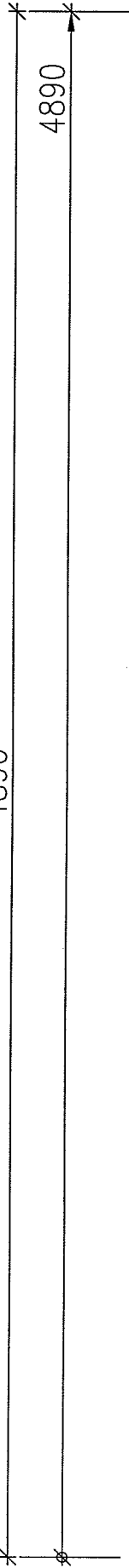

900

4890



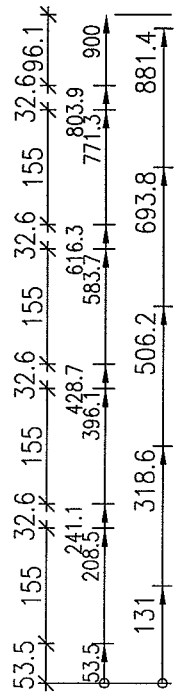
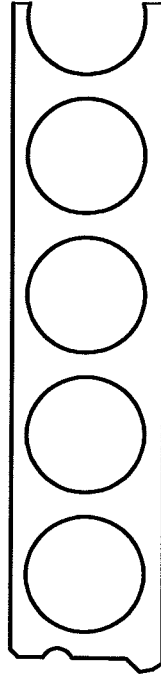

200



Reikä 
 Syvennys 

Laatan paino 245 kg/m²

Työn n:o	Piir. n:o
Pvm. 19.09.2007	Paloluokka REI30
PARMA	Piirtäjä
	
	
Kohde: Okt Mallinen Mallitie 1, 12345 Mallila	
Elementin tunnus	P20- -1
	1 kpl

1200

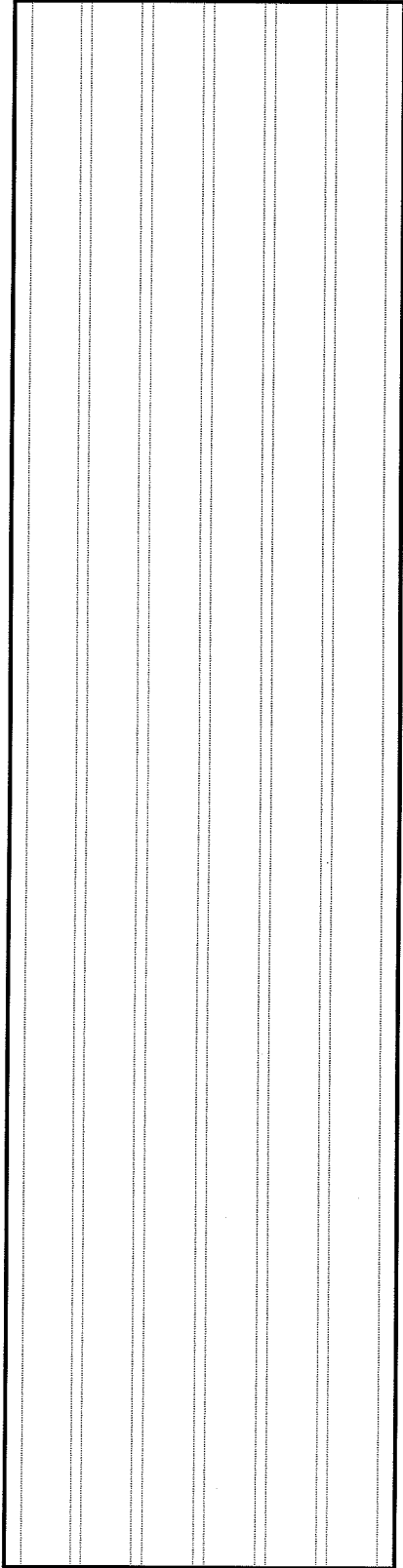

4890

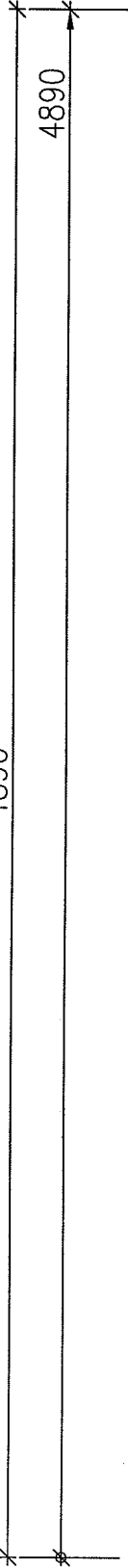

200

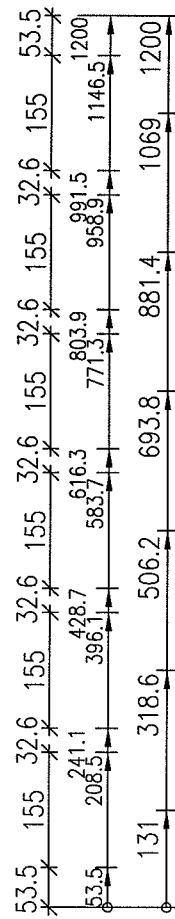
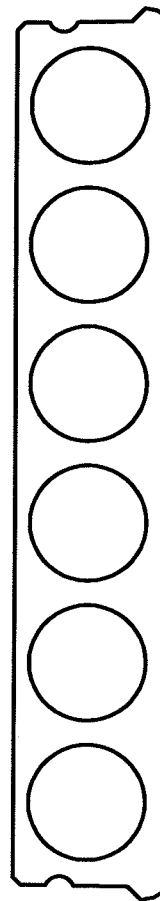

Reikä



Syvännys



Laatan paino 245 kg/m²

Työn n:o	Piir. n:o
Pvm. 19.09.2007	Paloluokka REI30
PARMA	Piirtäjä
	↑
	↑
	↑
Kohde: Okt Mallinen Mallitie 1, 12345 Mallila	
Elementin tunnus	P20- -2
	8 kpl

1200

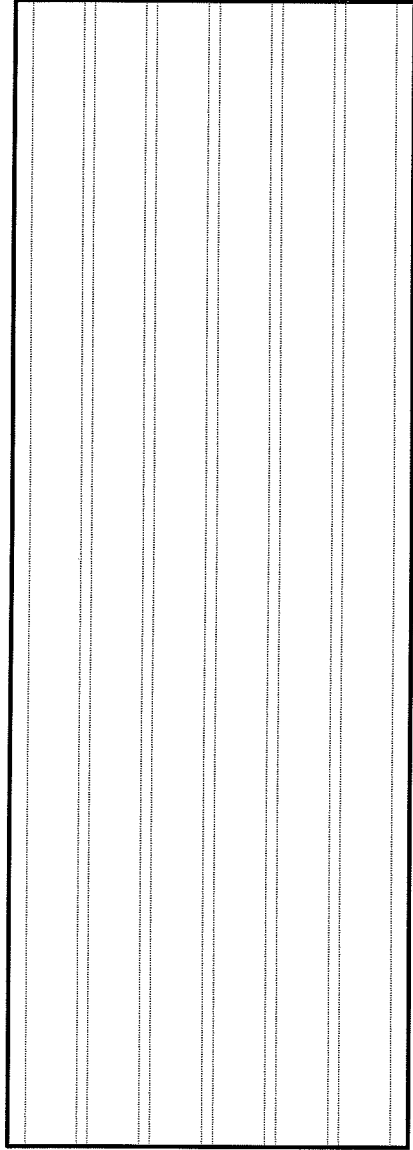

3490

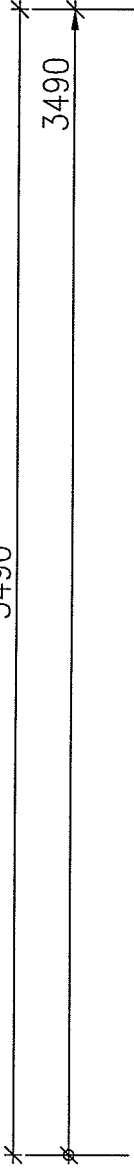

200

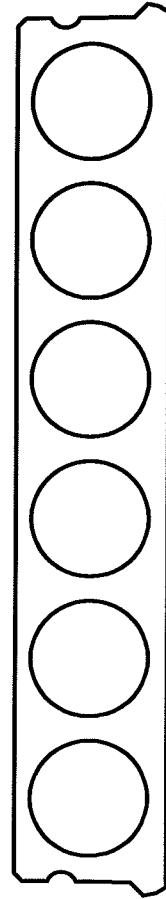

53.5	155	32.6	155	32.6	155	32.6	155	32.6	155	32.6	155	53.5
53.5	208.5	241.1	396.1	428.7	583.7	616.3	771.3	803.9	958.9	991.5	1146.5	1200
131	318.6	506.2	693.8	881.4	1069	1200						

Reikä

Syvennys

Laatan paino 245 kg/m²

Työn n:o	Piir. n:o
Pvm. 19.09.2007	Paloluokka REI30
PARMA	Piirtäjä
Kohde: Okt Mallinen Mallitie 1, 12345 Mallila	
Elementin tunnus	P20- -3
	2 kpl

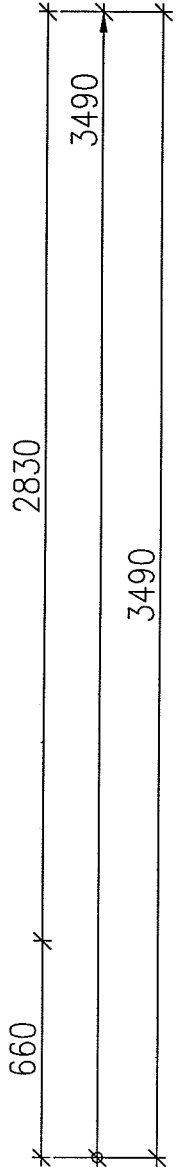
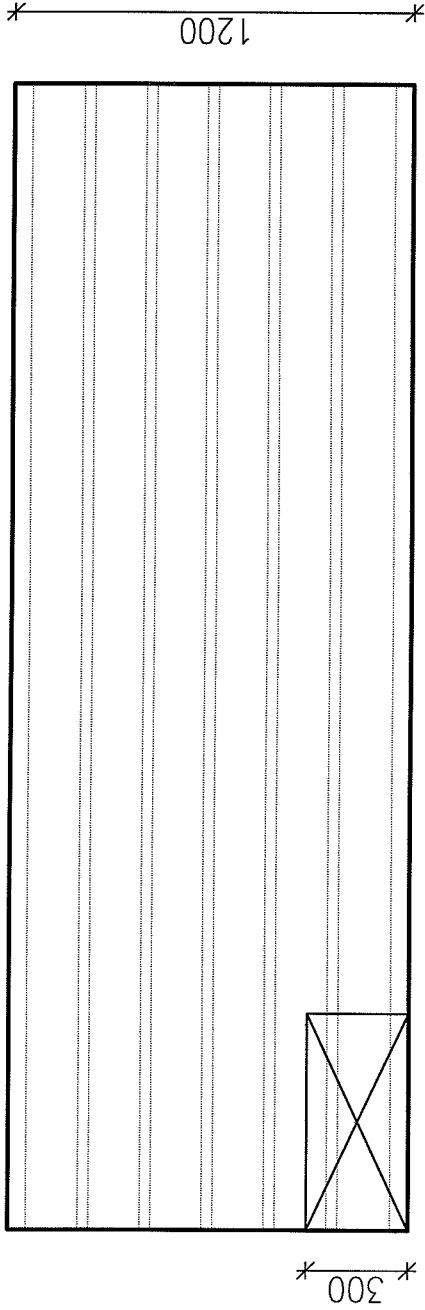

200

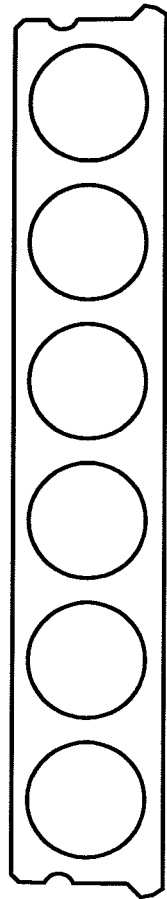



53.5	155	32.6	155	32.6	155	32.6	155	32.6	155	32.6	155	53.5
241.1	396.1	428.7	583.7	616.3	771.3	803.9	891.5	958.9	1146.5	1200		
53.5	208.5											
131	318.6	506.2	693.8	881.4	1069	1200						

Reikä 

Syvennys 

Laatan paino 245 kg/m²

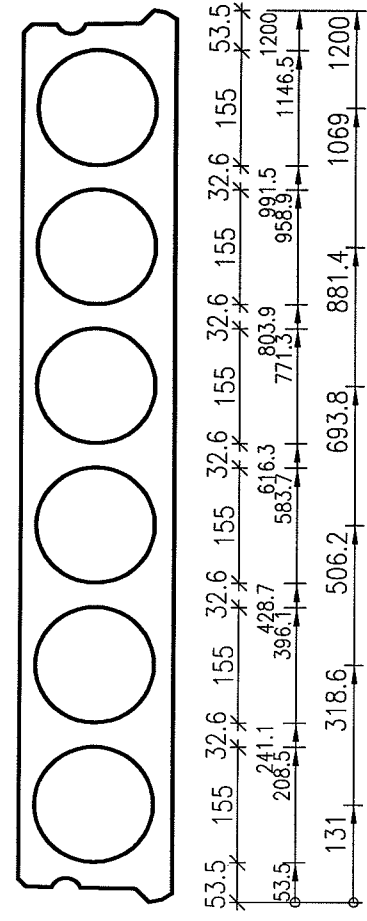
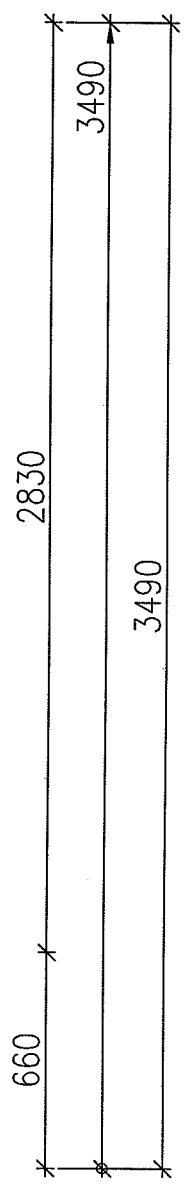
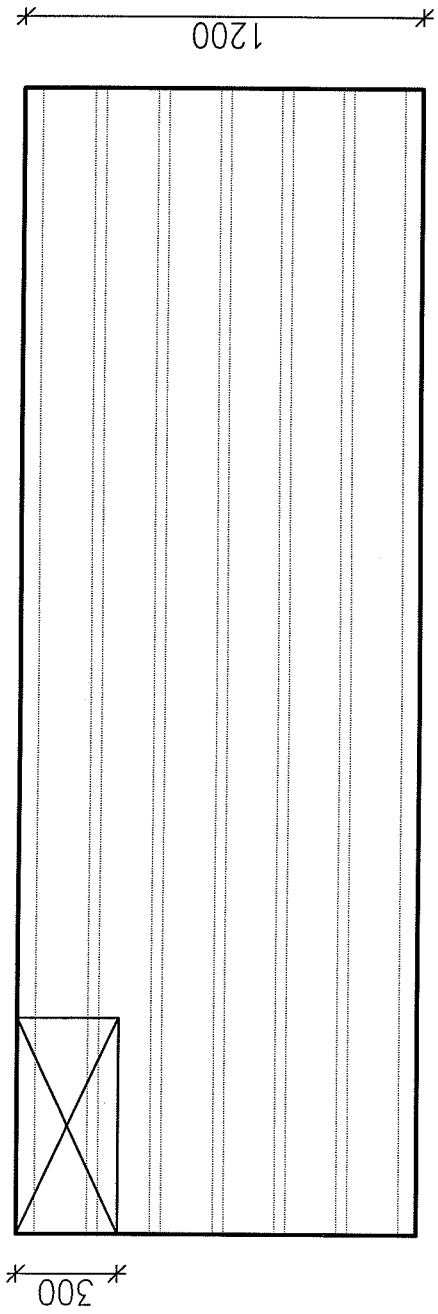

Työn n:o	Piir. n:o
Pvm. 19.09.2007	Paloluokka REI30
PARMA	
Piirtäjä 	
Piirtäjä 	
Piirtäjä 	
Kohde: Okt Mallinen Mallitie 1, 12345 Mallila	
Elementin tunnus	1 kpl
P20- -4	



Reikä 

Syvennys 

Laatan paino 245 kg/m²

Työn n:o	Piir. n:o
Pvm. 19.09.2007	Paloluokka REI30
PARMA	Piirtäjä
	
	
Kohde: Okt Mallinen Mallitie 1, 12345 Mallila	
Elementin tunnus P20- -5	1 kpl

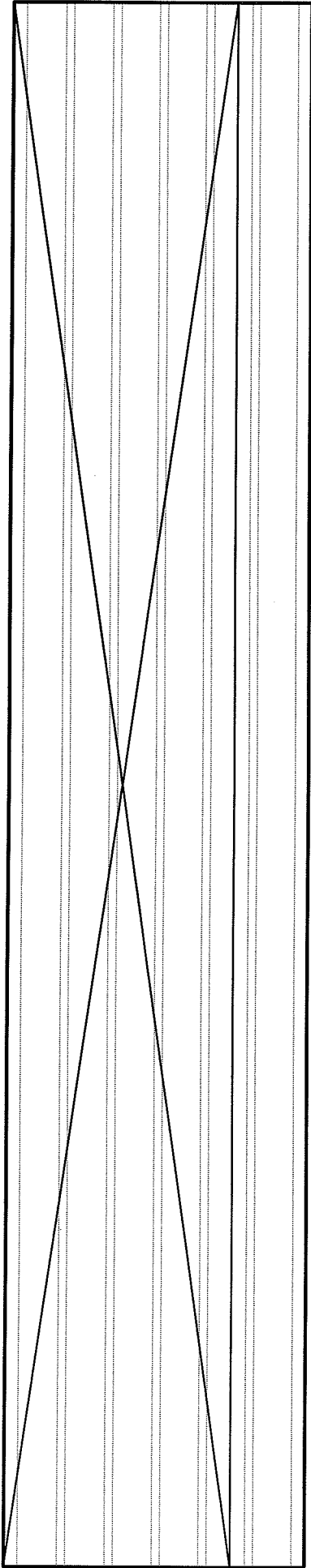

6370

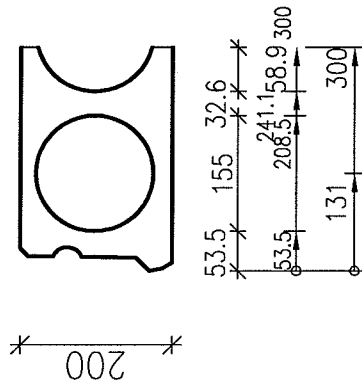
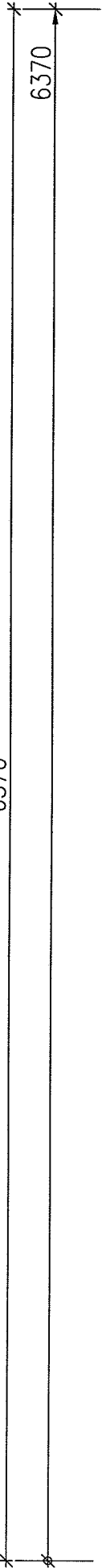

Reikä





Syvennys

Laatan paino 245 kg/m²

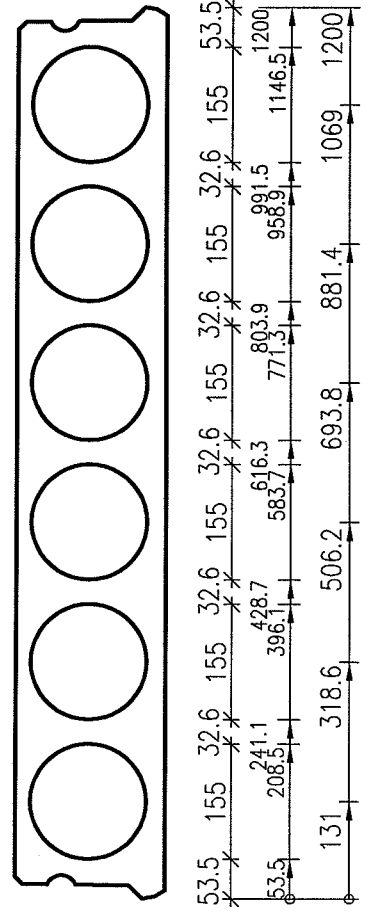
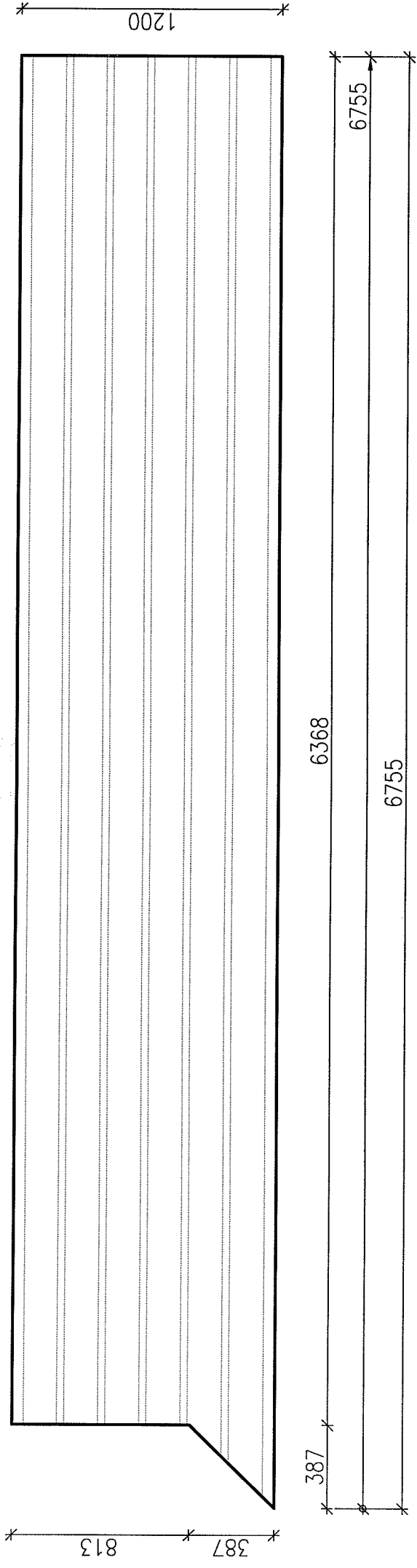
Työn n:o	Piir. n:o	
Pvm. 19.09.2007	Paloluokka	REI30
		Piirtäjä
		↑
		↑
Kohde: Okt Mallinen Mallitie 1, 12345 Mallia		
Elementin tunnus	P20- -6	1 kpl





Reikä 

Syvennys 

Laatan paino 245 kg/m²

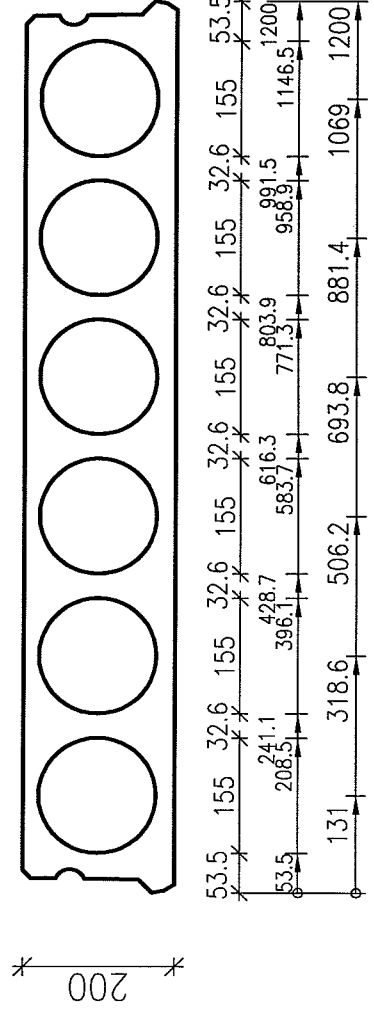
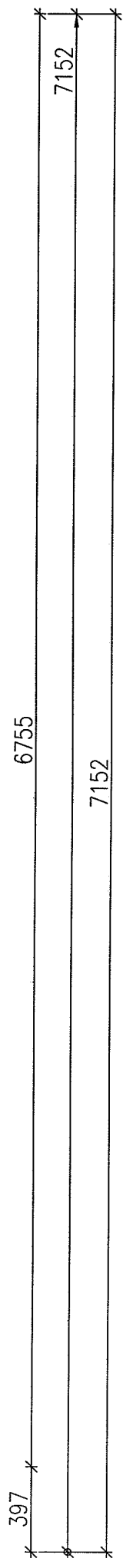
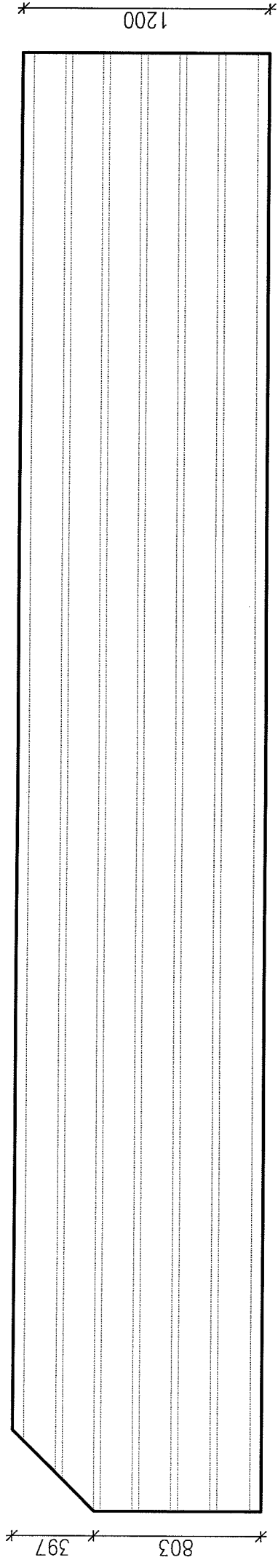
Työn n:o	Piir. n:o
Pvm. 19.09.2007	Paloluokka REI30
PARMA	
Piirtäjä	
↑	
↑	
↑	
Kohde: Okt Mallinen Mallitie 1, 12345 Mallila	
Elementin tunnus	P20- -7
	1 kpl





Reikä 
 Syvennys 

Laatan paino 245 kg/m²

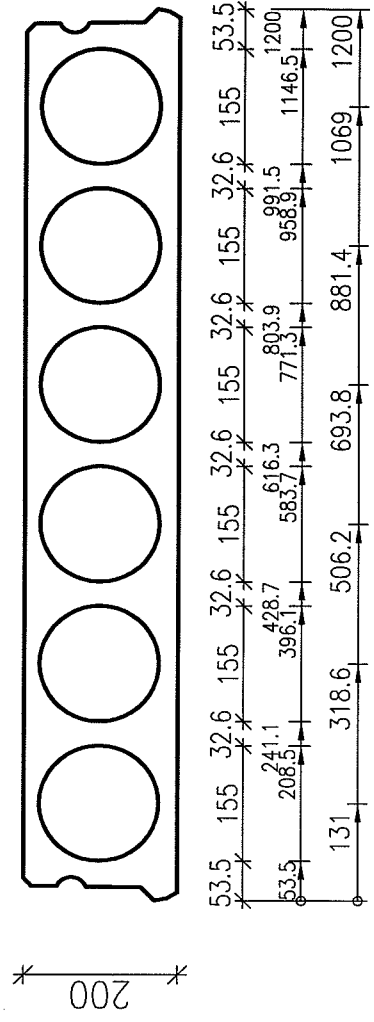
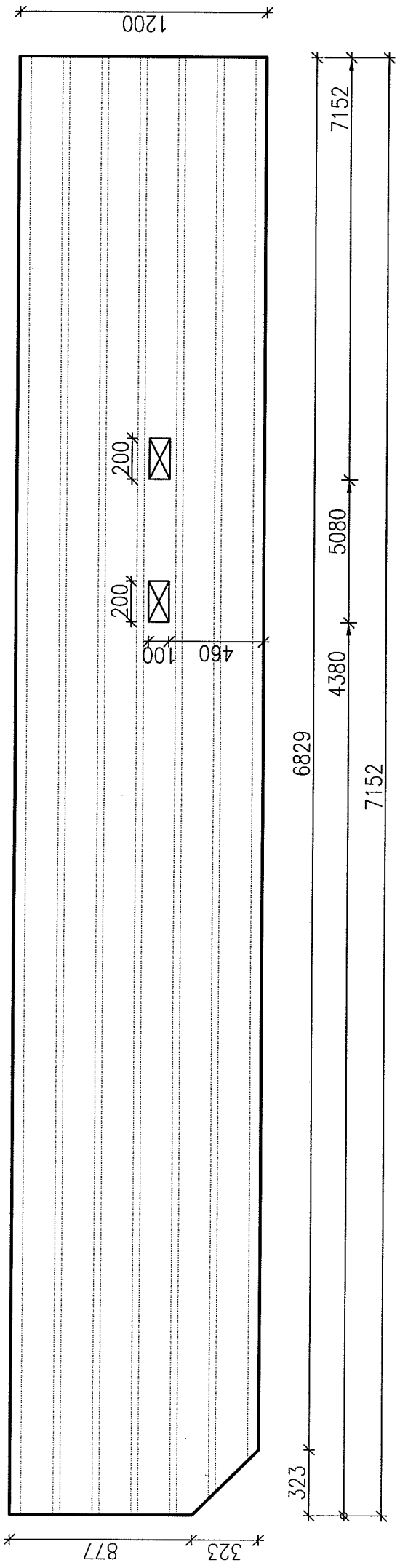
Työn n:o	Piir. n:o
Pvm. 19.09.2007	Paloluokka REI30
PARMA	
↑	
↑	
↑	
Kohde: Okt Mallinen Mallitie 1, 12345 Mailia	
Elementin tunnus P20- -8	1 kpl



Reikä  Syvennys 

Laatan paino 245 kg/m²

Työn n:o	Piir. n:o
Pvm. 19.09.2007	Paloluokka REI30
PARMA	
Piirtäjä	
↑	
↑	
↑	

Kohde: Okt Mallinen Mallitie 1, 12345 Mallia
 Elementin tunnus **P20--9** 1 kpl

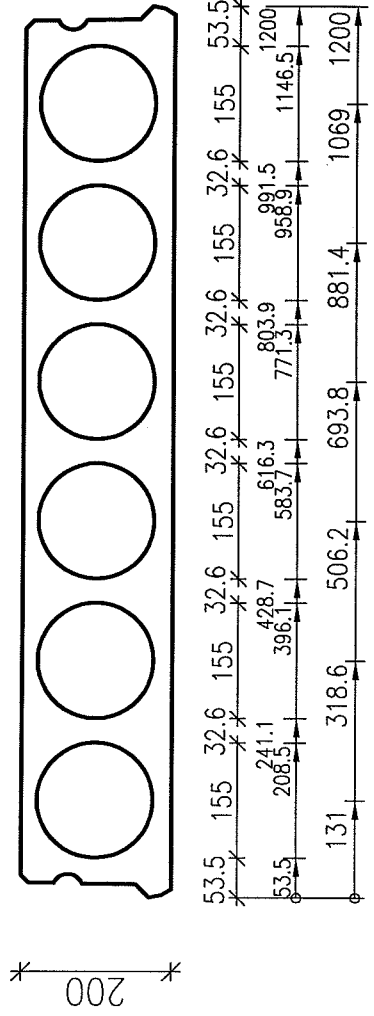
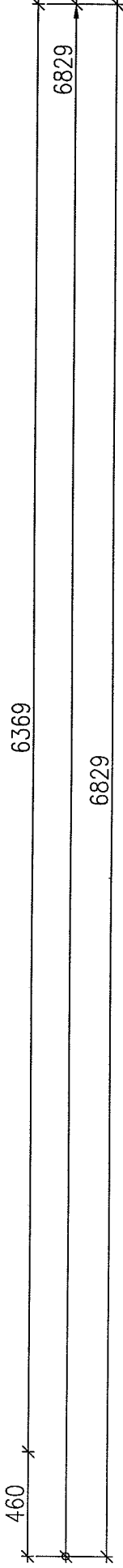
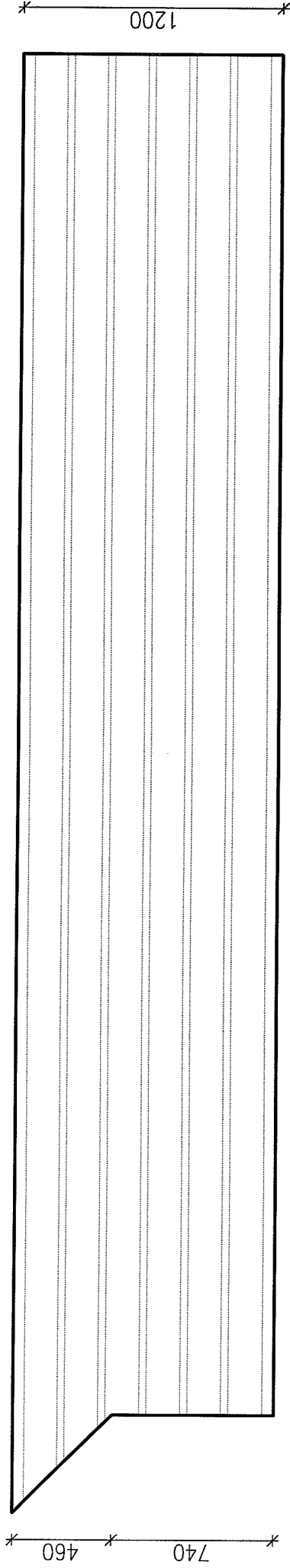

Reikä

Syvennys

Laatan paino 245 kg/m²

Työn n:o	Piir. n:o
Pvm. 19.09.2007	Paloluokka REI30
PARMA	Piirtäjä
Kohde: Okt Mallinen Mallitie 1, 12345 Mallia	
Elementin tunnus P20- -10	1 kpl

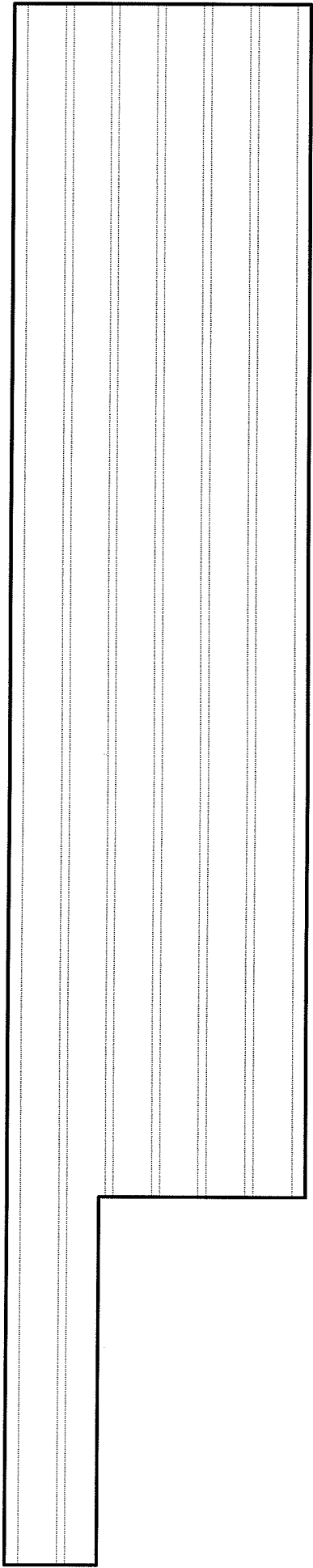

1200

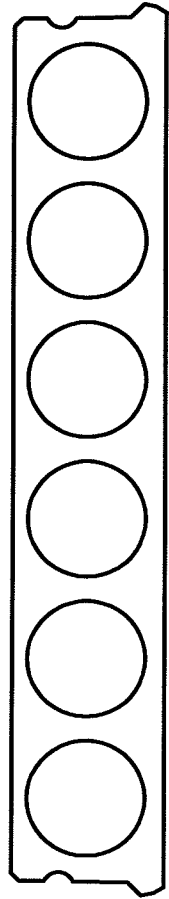

200



53.5 155 32.6 155 32.6 155 32.6 155 32.6 155 32.6 155 32.6 155 53.5
 53.5 208.5 241.1 396.1 428.7 583.7 616.3 771.3 803.9 891.5 958.9 1146.5 1200
 131 318.6 506.2 693.8 881.4 1069 1200

Reikä 
 Syvennys 

Laatan paino 245 kg/m²

Työn n:o	Piir. n:o
Pvm. 19.09.2007	Paloluokka REI30
PARMA	
Piirtäjä	
↑	
↑	
↑	
Kohde: Okt Mallinen Mallitie 1, 12345 Mallila	
Elementin tunnus	P20- -11
	1 kpl

1200

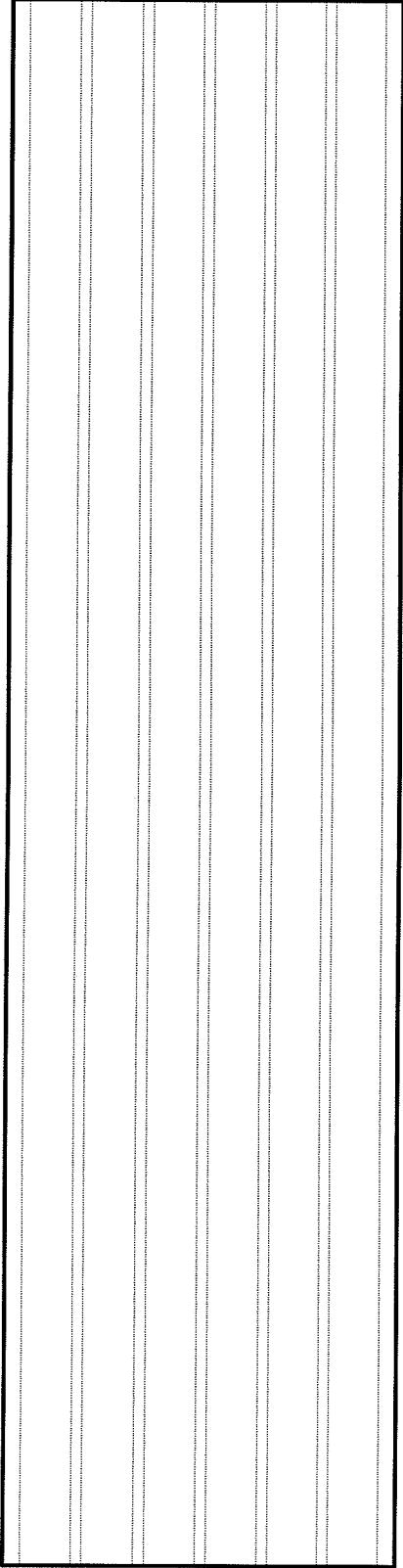

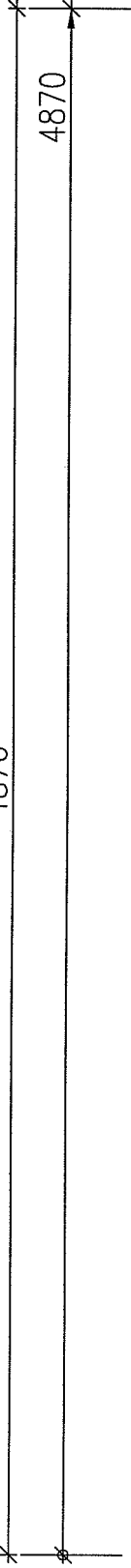

4870



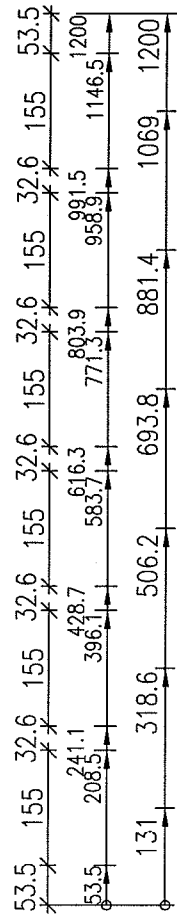
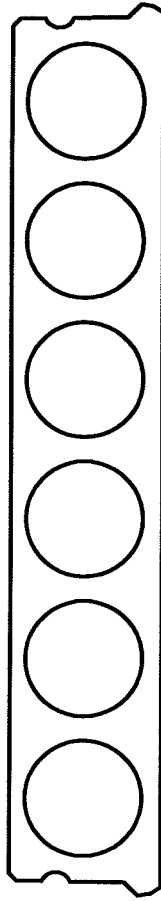

200





Reikä 
 Syvennys 

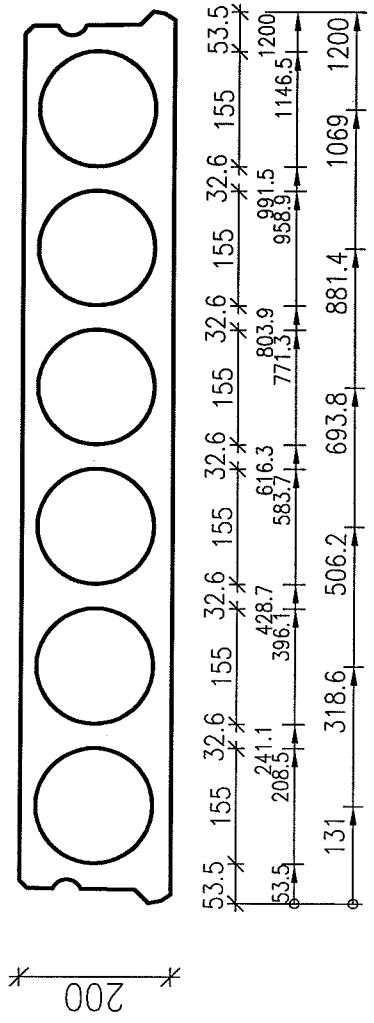
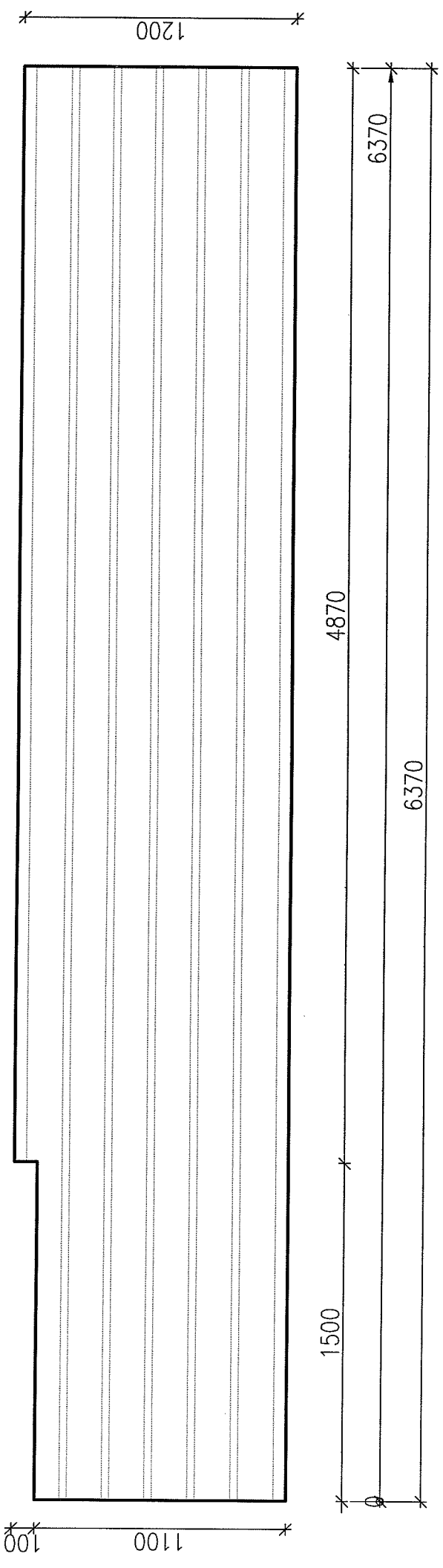

Laatan paino 245 kg/m²

Työn n:o	Piir. n:o
Pvm. 19.09.2007	Paloluokka REI30
PARMA	Piirtäjä
	
	
Kohde: Okt Mallinen Mallitie 1, 12345 Malilla	
Elementin tunnus	P20- -12
	5 kpl



Reikä 
 Syvennys 

Laatan paino 245 kg/m²

Työn n:o	Piir. n:o
Pvm. 19.09.2007	Paloluokka REI30
PARMA	Piirtäjä
	
	
Kohde: Okt Mallinen Mallitie 1, 12345 Mallia	
Elementin tunnus	P20- -13
	1 kpl

1200

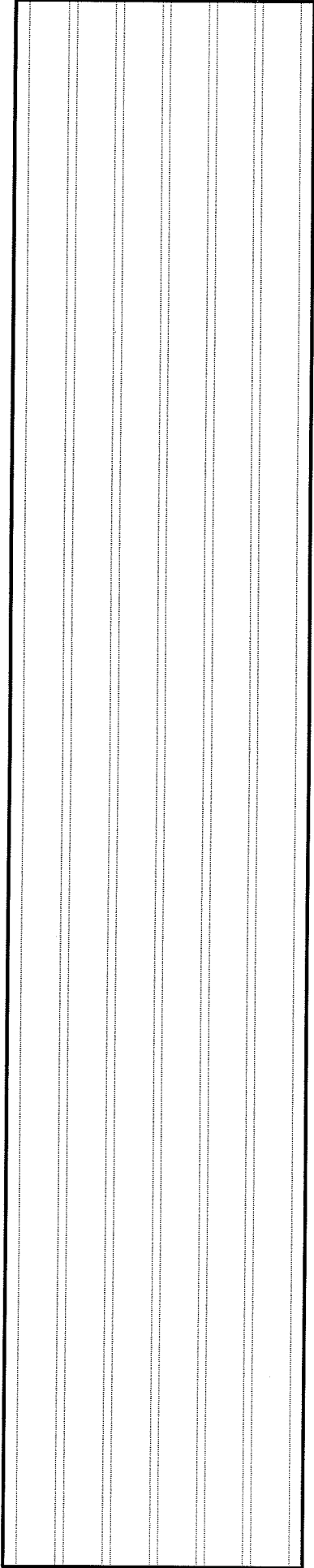

6370

6370

200

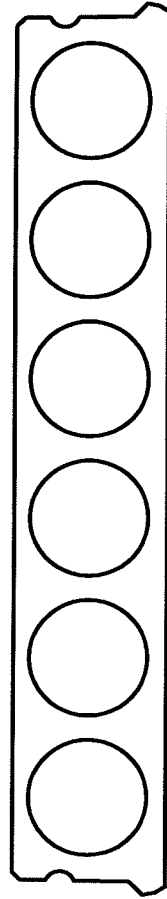

53.5	155	32.6	155	32.6	155	32.6	155	32.6	155	32.6	155	53.5
53.5	208.5	241.1	396.1	428.7	583.7	616.3	771.2	803.9	958.9	991.5	1146.5	1200
131	318.6	506.2	693.8	881.4	1069	1200						



Reikä



Syvennys

Laatan paino 245 kg/m2

Työn n:o	Piir. n:o
Pvm. 19.09.2007	Paloluokka REI30
PARMA	Piirtäjä
	↑
	↑
Kohde: Okt Mallinen Mallitie 1, 12345 Mallila	
Elementin tunnus	P20- -14
	3 kpl